



One touch selection to total air comfort



**Intelligent touch Manager**



# ALL IN ONE

System solution for management of building air conditioning

# One touch selection enables



Various types of equipment in a building can be controlled by a single controller.

## Individual air-conditioning control

The flexible control achieved by the VRF system precisely meets different air conditioning needs in each room (e.g. offices, conference rooms, hotel rooms).



## Lighting control **DALI-compatible**

DALI-compatible LED lighting systems can be controlled and monitored. Lighting control is enhanced through an interlock function with air conditioners and other functions.

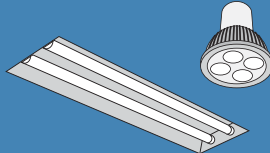

## Air-conditioning control for large spaces

Air handling units can also be controlled. Large spaces, such as entrance halls and shopping malls, can be easily controlled to ensure comfort.



## Building equipment control

Various types of equipment other than air conditioners, including ventilators, fans, and pumps, can also be controlled.

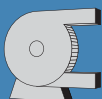

Pump



Fan

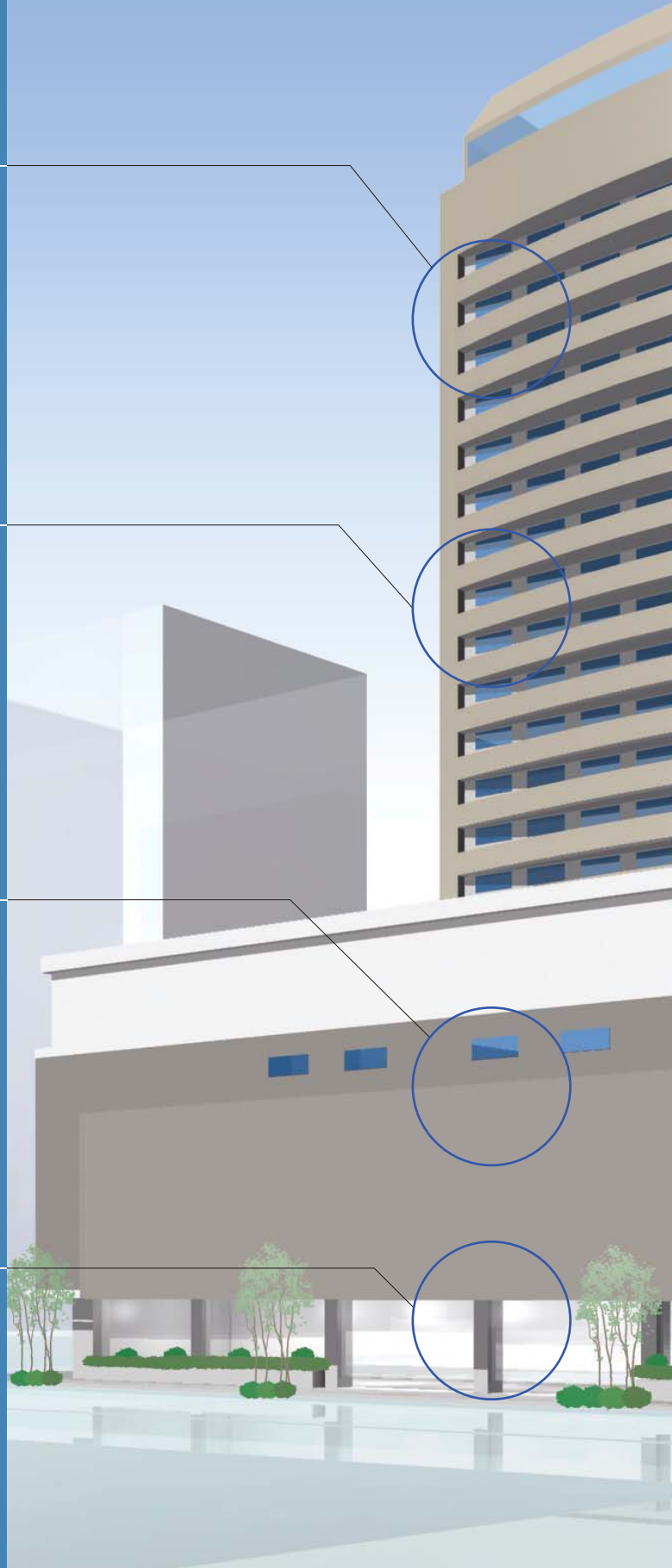

# flexible control of equipment in a building.

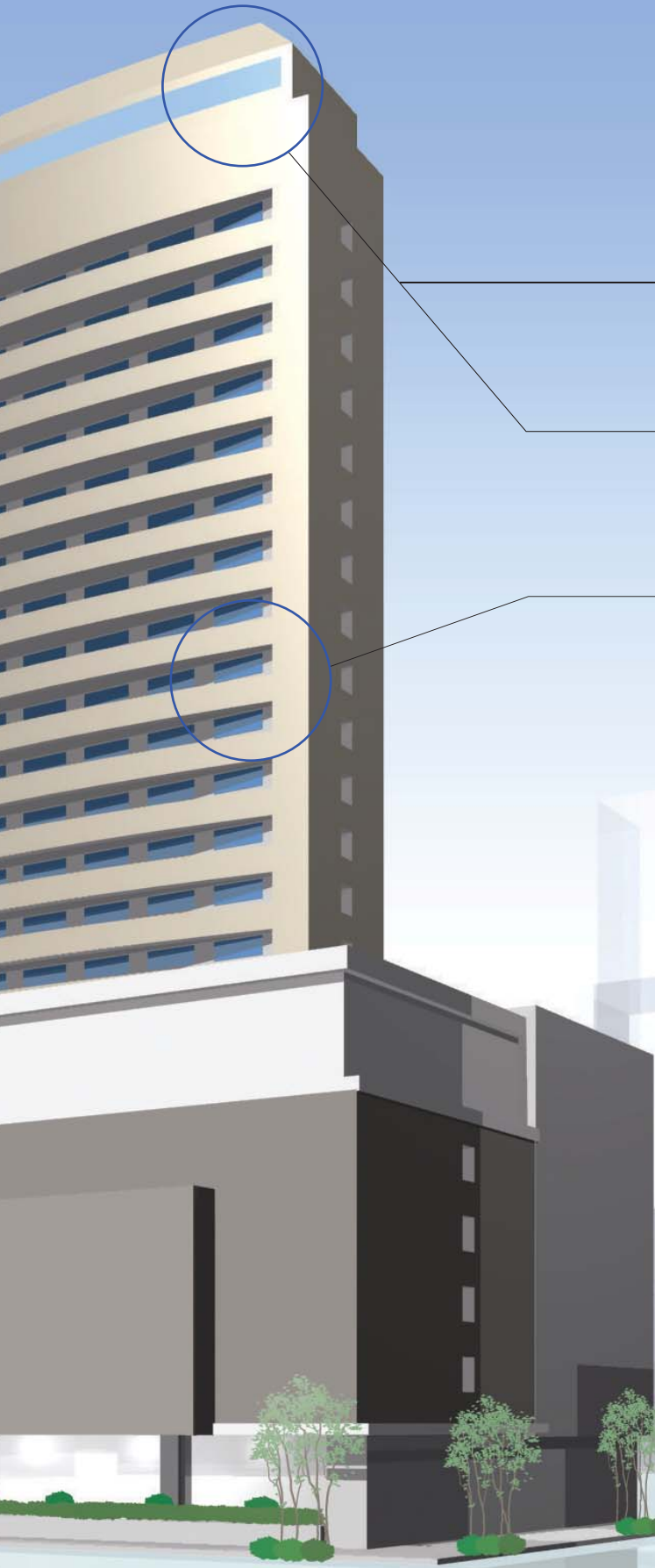

### Energy control

The status of energy consumption in a building (e.g. electricity, gas) can be checked and analyzed. The data can then be effectively utilized to ensure energy-efficient operation.

### Environmental monitoring

The indoor environment (e.g. temperature, humidity, illuminance) can be monitored via various sensors. This feature is effective for controlling and maintaining comfort.

### Smart phone operation

Air conditioners can be operated by smart phones via Wi-Fi. This feature is effective as a value-added service for tenants etc.



Smart phone



You can control VRV system from anywhere through Wi-Fi

### Energy-efficient control of air conditioning and lighting is the key to cutting energy costs.

Electricity consumption ratio in typical office buildings

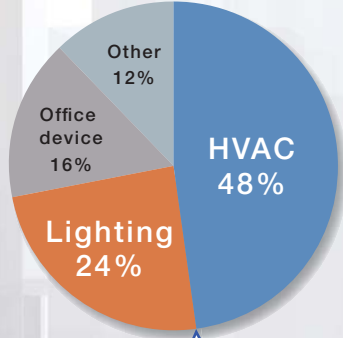

HVAC and lighting account for 72%.

Source: Agency for Natural Resources and Energy, Government of Japan

# By controlling the VRF system using the *intelligent Touch Manager*, energy saving can be promoted while maintaining comfort

## Comfort with minimum energy

In office buildings, approx. 30-50% of total electricity consumption is occupied by air conditioning. *intelligent Touch Manager* provides a huge potential of cost saving.

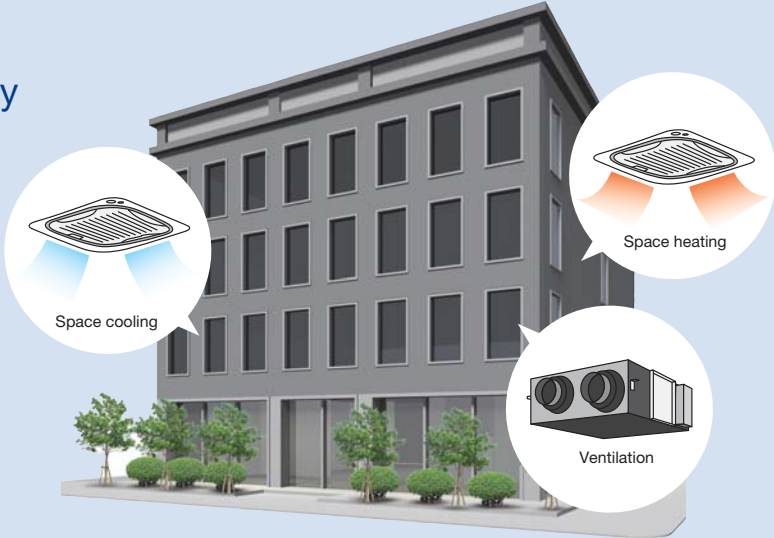

<h3>Schedule the operation time for each application.</h3> <ul style="list-style-type: none"> <li>Office: 8:00-18:00</li> <li>Reception: 9:00-17:00</li> <li>Admin: 8:30-17:00</li> <li>Machine room: 24 hours</li> <li>Manager room: 8:00-20:00</li> <li>Common area: 9:00-17:00</li> <li>Meeting room: No schedule</li> </ul>	<h3>Define the setpoint range that users can change.</h3> <p><b>With Remote controller</b></p> <p><b>With Control System</b></p> <p>Set point range 22°C - 28°C</p>
<h3>Turn the unit OFF if a user didn't.</h3> <p>Working hours (Scheduled)</p> <p>Turn ON again by remote controller, forgot to turn OFF, and left.</p> <p>Turn off as scheduled</p> <p>Automatically turn OFF to cut wasteful operation</p> <p>Saved power consumption by control system</p>	<h3>Reset setpoint regularly.</h3> <p>Change to 20°C</p> <p>Stop Start</p> <p>Set at 24°C</p> <p>Reset to 24°C</p> <p>Saved power consumption by control system</p>

# Air-conditioning power consumption can be reduced by 20 to 30%, using energy-efficient control

## Case Study at actual building

### CASE 1: Office

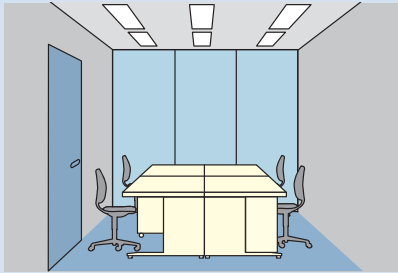

#### Project detail

Floor area: 1,400m<sup>2</sup>

VRV ODU: 100HP

\* Verification target is only for 8th floor of the building.

#### Background

- All control was done by users with local remote controllers.
- No centralized controller was installed

#### What's New

- Our centralized controller has been installed.
- The following three control logics have been newly added.

The air-conditioning power consumption was cut by **32%**.

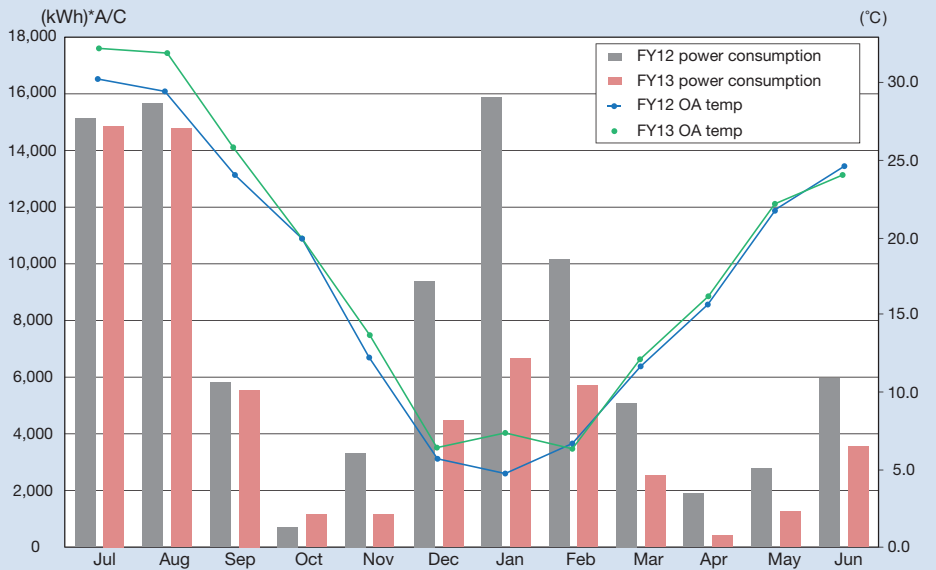

New control	Content
Setpoint restriction	24-32°C (Cooling) 16-20°C (Heating)
Setpoint reset every morning	26°C (Cooling) 18°C (Heating)
Turn OFF by schedule	17:30 and 21:00

## Case Study at actual building

### CASE 2: University

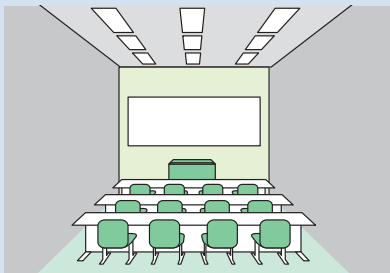

#### Project detail

Floor area: 8,100m<sup>2</sup>

\*900m<sup>2</sup> / floor VRV ODU: 796HP

#### Background

- All control was done by users with local remote controllers.
- No centralized controller was installed.
- Setpoints were not controlled.

\* Less than 20°C on average.

The total power consumption in the building was cut by **26%**.

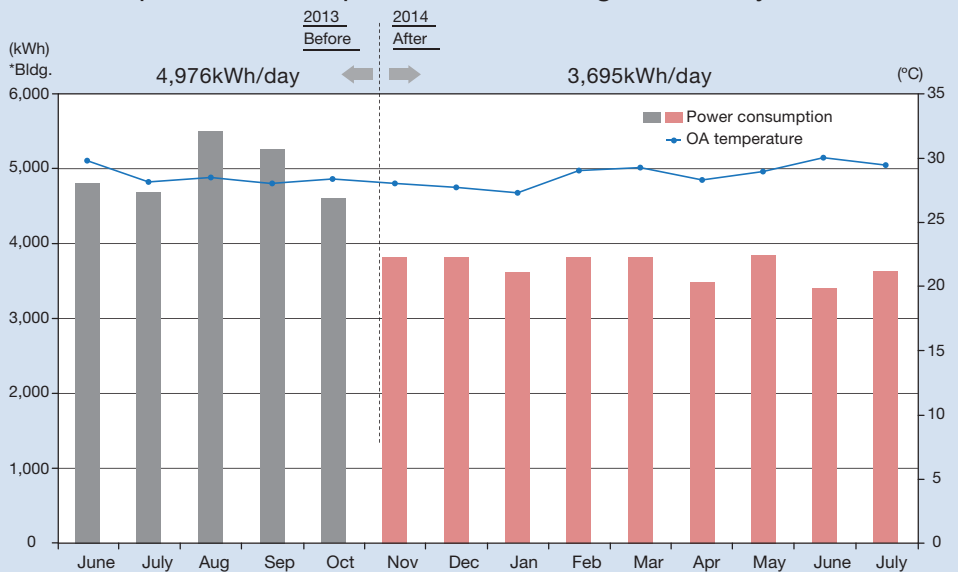

#### What's New

- Our centralized controller has been installed.
- The following three control logics have been newly added.

New control	Content
Setpoint restriction	22-32°C (Cooling)
Setpoint reset everyday	24°C (Cooling)
Turn OFF by schedule	19:00 and 21:00

# For Energy Saving & Comfort

## *intelligent Touch Manager* maximises the advantages of VRV features

*intelligent Touch Manager* is an advanced multi-zone controller that provides the most cost-effective way to control and monitor the Daikin VRV system.

The 10.4" LCD touch screen is easy to use with three different screen views to include the floor plan layout view, icon view and list view and menus for system configurations.

It is also easy to use with standardized remote Web Access from your PC.

It can manage a total of 650 management points consisting of up to 512 Daikin indoor unit groups ( up to 1024 indoor units ) along with building equipment control / monitoring with Digital Inputs / Output ( Di/Dio ) , Analog Inputs / Output ( Ai/Ao ) and Pulse input ( Pi ) optional devices.

## Only When and Where Necessary

Flexible control can be achieved to meet air conditioning needs in each room

Saving energy by preventing wasteful operation in unoccupied periods



Requirements for air conditioning system depend on the application of buildings.

In this example, each floor of the office building is occupied by different tenants, and they have their own preferences due to their working days and hours.

*intelligent Touch Manager* has the flexible schedule programme which can set specific operation days, time, and setpoint for each tenant or even each indoor unit. Therefore the air conditioning system can operate only when and where necessary irrespective of the motivation for energy saving of the tenants.

### Tenant 1

Working day: Mon - Fri  
Working hours: 9:00 - 17:30  
Setpoint: 24°C

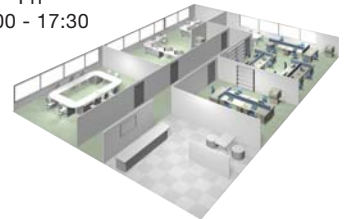

### Tenant 2

Working day: Mon - Fri  
Working hours: 8:00 - 17:00  
Setpoint: 22°C

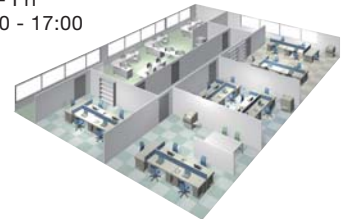

### Tenant 3

Working day: Mon - Sat  
Working hours: 8:00 - 19:00  
Setpoint: 25°C



### Tenant 4

Working day: Mon - Sun  
Working hours: 7:00 - 23:00  
Setpoint: 20°C

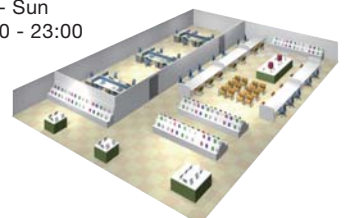

# In addition to switching lights on and off, advanced lighting control, such as illuminance adjustment, can be achieved

## Lighting control (Option)

### Connection to DALI - compatible lighting control system

Simple wiring (daisy chain) enables management of LED lighting by the *intelligent Touch Manager*.

Various air conditioning and lighting control is enabled through the interlock with occupancy sensors and illuminance sensors.

**DALI-compatible**

Please contact your local sales office for details.

#### Lighting control achieved by the *intelligent Touch Manager*

##### [ Operation ]

- Switch-on/switch-off operation
- Illuminance (1–100%) control
- Various illuminance patterns can be registered
- Registered pattern can be selected from *intelligent Touch Manager*

##### [ Monitoring ]

- Switch-on/switch-off status monitoring
- Lighting abnormality monitoring
- Illuminance monitoring
- DALI occupancy sensor monitoring
- DALI illuminance sensor monitoring

Air conditioning and lighting for which power consumption is high can be efficiently controlled to promote energy conservation and cost reduction!

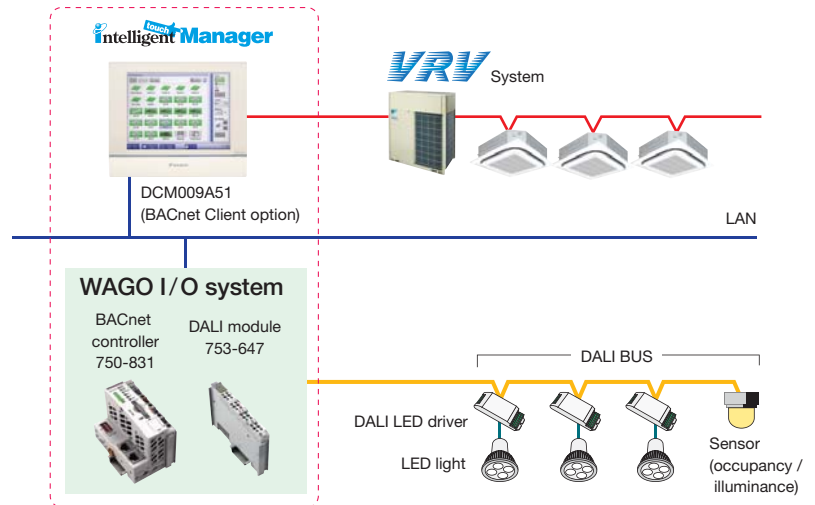

#### [ Overview of control ]

- Up to 5 DALI modules can be connected to a single BACnet controller.
- Up to 64 DALI LED drivers (64 addresses) can be connected to a single DALI module.
- 64 DALI addresses can be freely assigned to up to 16 groups using a single DALI module. (Each group corresponds to a management point of the *intelligent Touch Manager*.)
- Up to 16 scenes can be set to a single DALI module.
- Up to 12 sensors (occupancy, illuminance) can be connected to a single DALI module.
- DALI BAS simplifies wiring and setting work by daisy chain wiring and automatic address setting.

## Easy maintenance and energy saving by lighting control

### Case1

Switch-on / switch-off and illuminance are controlled based on a schedule to cut wasteful power consumption.

- Failing to switch off lights is prevented.



- Optimal illuminance reduces energy.

### Case2

Occupancy sensors are used to eliminate both wasteful lighting and air conditioning. When a room is unoccupied, the air conditioning stops and the lighting is switched off.

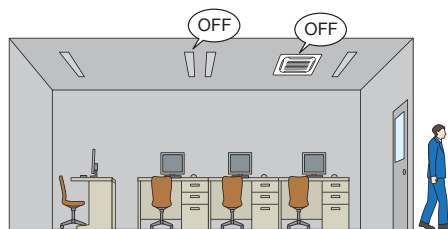

### Case3

Lighting abnormalities (e.g. burned-out bulbs) can be checked on the *intelligent Touch Manager* screen.

Lighting maintenance becomes easier and quicker.

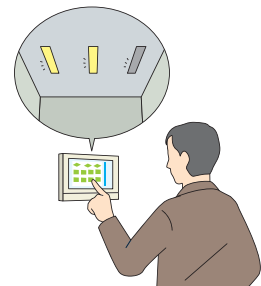

The layout screen enables quick identification of specific locations.

# Not Only VRV System, but Also Other Building Equipment

Integrated control for air conditioning in large spaces can be achieved by a single controller

A wide variety of equipment can be connected

*intelligent Touch Manager* covers not only the VRV system but also other air conditioning systems (e.g. air handling units) and building equipment (e.g. sensors).

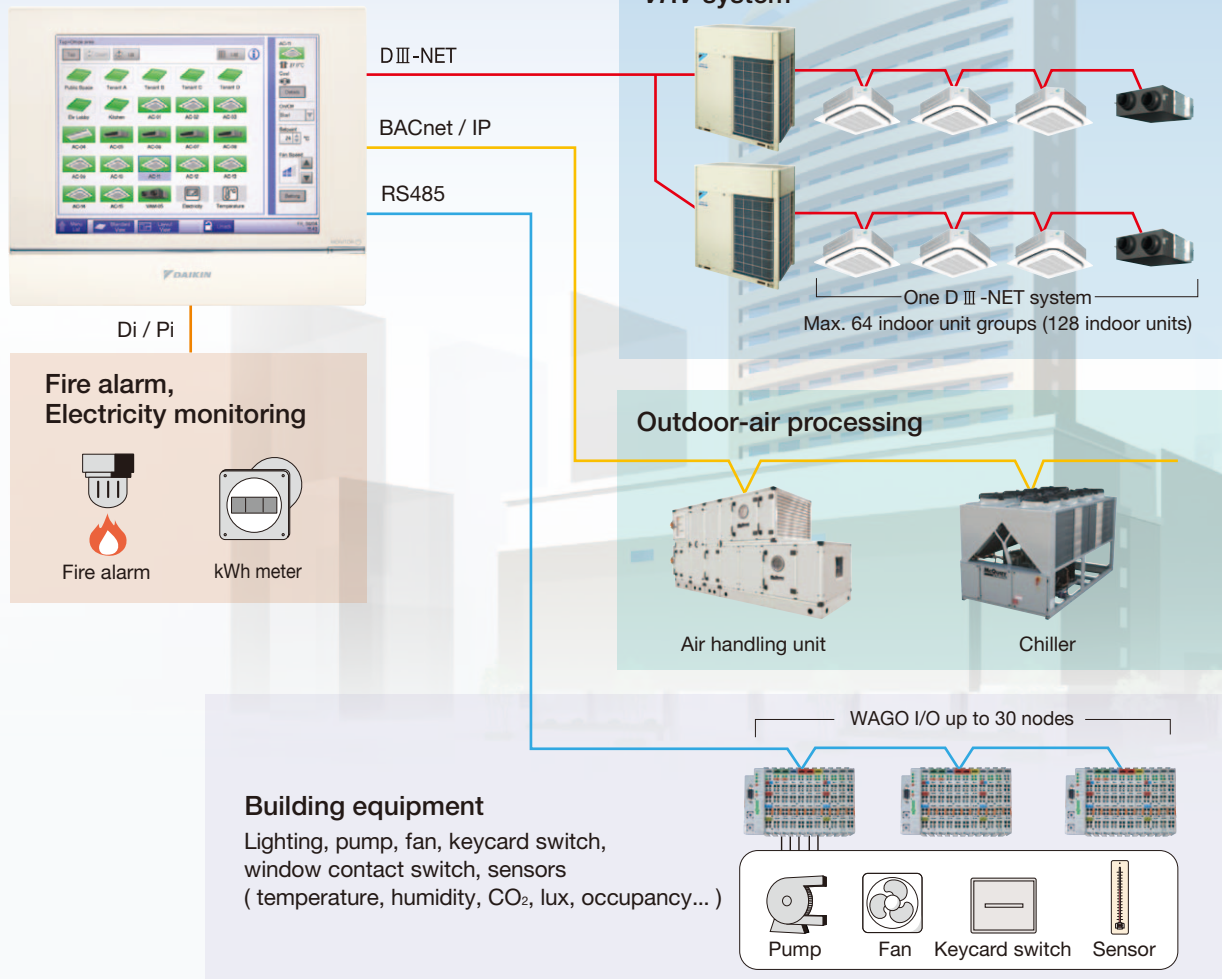

## Effective service functions offered to tenants

Smart phone will be a remote controller of VRV system (Option)

Users can operate and check the status of VRV system from their smart phones via Wi-Fi. It is not necessary to move where a remote controller is located with this feature. VRV system in other rooms can be operated, and their status can be checked. It is also possible to check if air conditioners in other rooms remain switched on etc., helping achieve energy saving.

**For buildings** VRV Smart Phone Remote Controller To be released in August 2016

Up to 512 indoor units can be controlled.

Just add SVMPC2 to this system

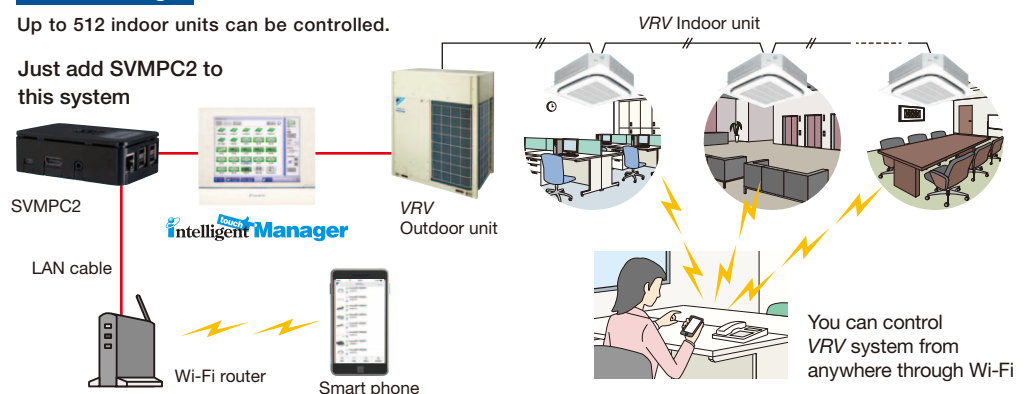



# Remote monitoring

## Multiple buildings can be managed from one site

### Remote monitoring control

The Web function enables management for the Daikin VRV system with other building equipment integrated into *intelligent Touch Manager* that can be accessed from your PC\*.

All operations and system configurations which you can do on the *intelligent Touch Manager* touch screen can be done through Web access.

E-mail alert enables prompt response by service engineers based timely and precise knowledge of what happened in the system at the remote site.

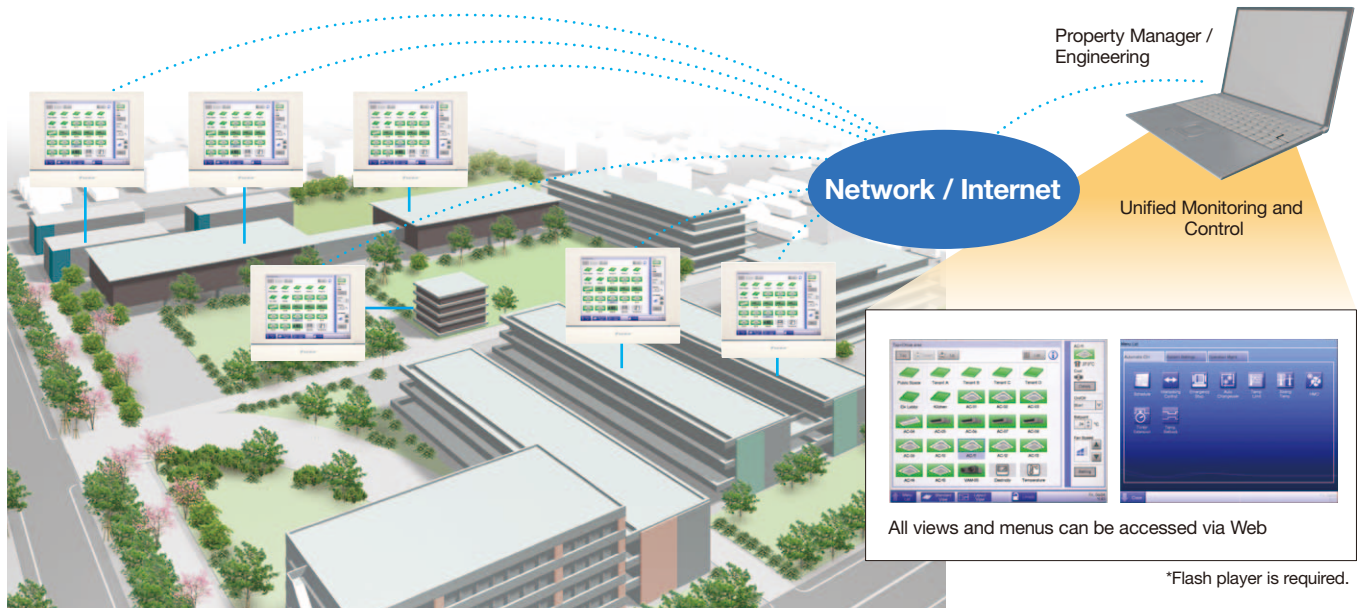

### E-mail alerts for reporting malfunctions

E-mail alerts are sent immediately to inform concerned parties of malfunctions involving equipment connected to the *intelligent Touch Manager*. Conveying equipment models and error codes, these e-mail alerts enable recipients to take prompt action and can be set for specific equipment.

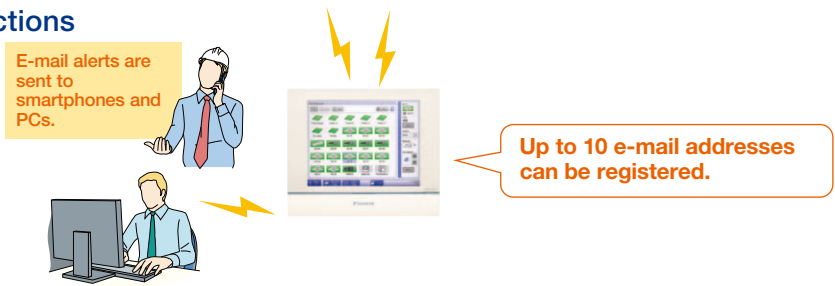

### For house VRV Smart Phone Control System

Up to 64 indoor units can be controlled.

Just add SVMPR2 to this system

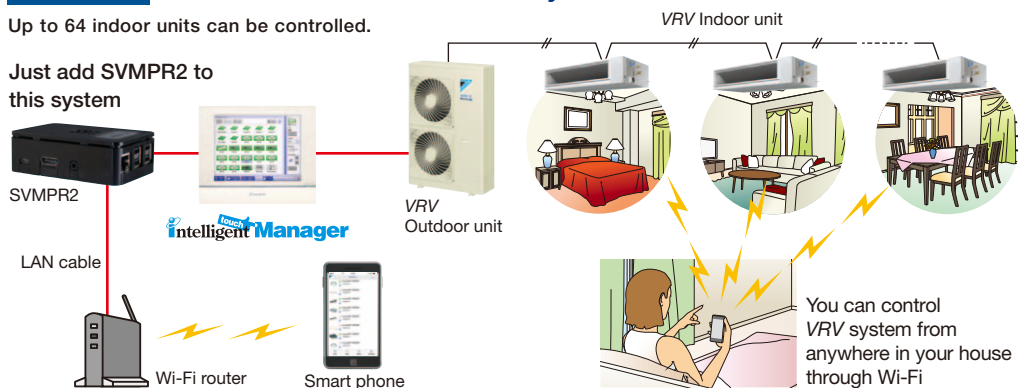

# Energy Management ( Energy Navigator Option )

## Motivating for further energy saving

### Energy saving assisted by Energy Navigator (Option)

Energy consumption trends of all the equipment (including air conditioning units) can be easily understood by using the Energy Navigator feature.

Here users can identify air conditioning units that are suspected of overcooling or kept running in unoccupied rooms.

The Energy Navigator feature will also provide support in formulation and verification of energy-saving measures to help ensure advanced energy management.

Hourly energy consumption is measured and the *intelligent Touch Manager* records data sent from the electrical meter.

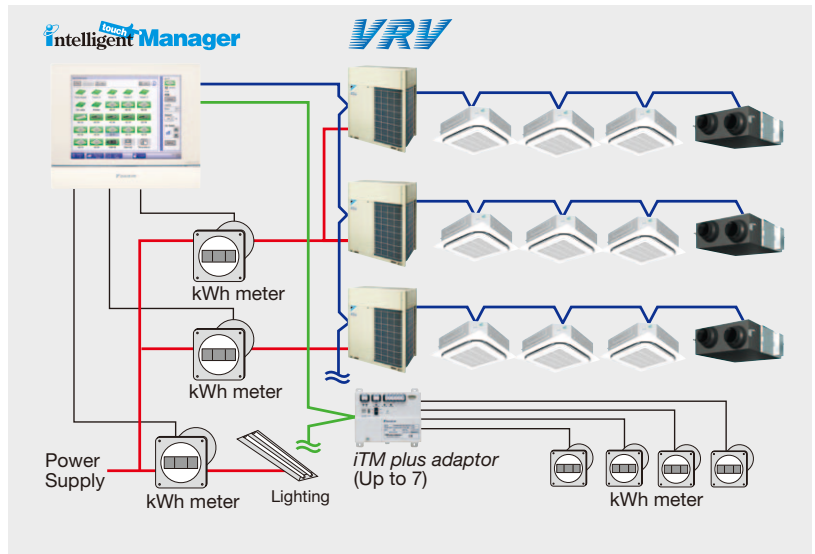

Accumulated data appears in an easy-to-understand graph.

Energy consumption data is presented on a daily and monthly basis. Also, energy targets and projected energy consumption data as well as comparison data with the previous year's actual results are presented in a user-friendly format to help ensure energy-saving control.

Daily energy consumption

- ① Warning indication
- ② Actual daily energy consumption
- ③ Cumulate line
- ④ Current month's target
- ⑤ Prediction line
- ⑥ Daily average to achieve month's target

Monthly energy consumption

- ① Warning indication
- ② Actual monthly energy consumption
- ③ Monthly target energy consumption
- ④ Cumulate line
- ⑤ Current year's target
- ⑥ Prediction line
- ⑦ Monthly target to achieve year's target

Comparison from the previous year

- ① Current year's energy use
- ② Current year's cumulate line
- ③ Previous year's cumulate line
- ④ Previous year's energy use



### Energy consumption is automatically evaluated for each room.

Based on the accumulated data, the *intelligent Touch Manager* automatically identifies rooms and air conditioning units that substantially deviate from operation rules established by the user for operation time and predetermined temperature settings. A benchmark showing ways to further reduce energy consumption can be displayed to alert users to even greater energy and cost savings.

The screenshot shows a table of room data and a scatter plot. The table lists room names, actual energy consumption, and deviation metrics. The scatter plot shows 'Actual Time (h)' on the y-axis and 'Occurrence days (Day)' on the x-axis. A yellow callout box points to a data point in the upper right area of the graph.

Name	Actual	Cost/hrs	Cons./day
1102	4.33	5	9.000h
1103	4.33	5	9.000h

- ① Plot area
- ② Number of hours of rule deviation
- ③ Number of days of rule deviation
- ④ Room name
- ⑤ Number of hours and days of rule deviation
- ⑥ Extra energy consumption

The degree of rule deviation increases toward the upper right area of the graph.

# Tenant Management (PPD\* Option)

## Reporting the power consumption of VRV system for each tenant

With the PPD function, power consumption can be calculated for each indoor unit (Option)

The energy consumption is proportionally calculated for each indoor unit. The data can be used for energy management and calculation of air conditioning usage fees for respective tenants.

Operational information of individual indoor units are monitored, based on distribution of power consumption of outdoor units.

Daikin's PPD keeps track of power distribution for each indoor unit. It performs air conditioning billing calculations quickly and automatically.

**It is easy to output PPD data.**  
PPD data is output in CSV format to a PC or USB memory device and can be freely processed and managed.

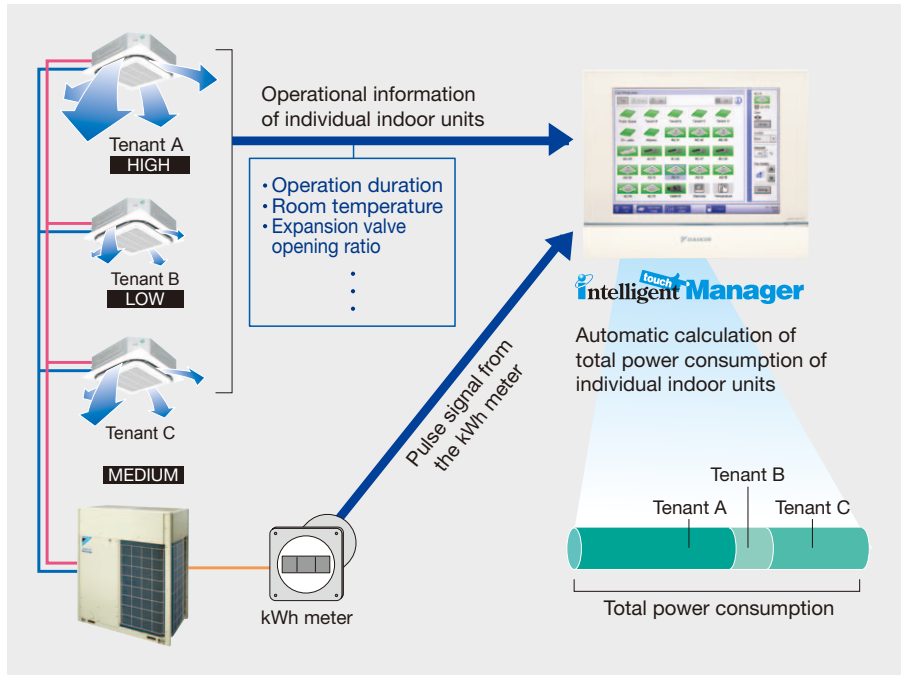

\* PPD (Power Proportional Distribution) is Daikin's proprietary calculation method.

## Air conditioning bills can be issued by one click

Electricity bills can be easily calculated for each tenant (Option)

The power consumption of VRV controlled by the intelligent Touch Manager can be easily managed for each tenant using a PC. The electricity bill settings facilitate billing work through easy calculation and issuance of VRV electricity bills.

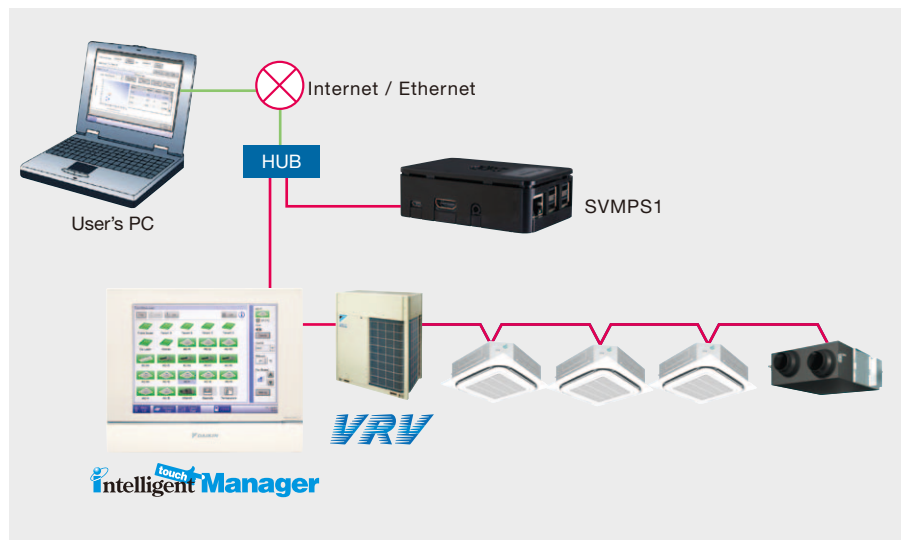
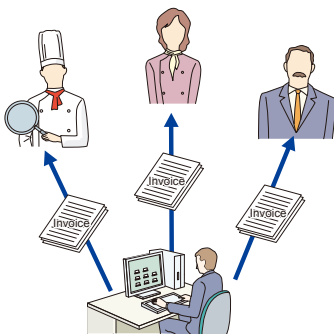

- [ Main functions ]
- Register tenants
  - Set the electricity unit price for 5 time zones
  - Calculate power consumption and electricity charge for each tenant
  - Show aggregation results in the specified period for each tenant
  - Output the results (Printout and CSV file)

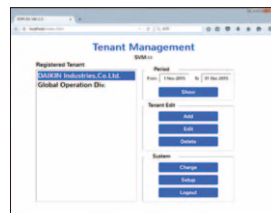

Tenant registration screen



Setup screen



VRV electricity bill screen

# Specifications

## intelligent Touch Manager function

Category	Function	Remarks	
Basic functions	<i>iTM plus adaptor</i> (DCM601A52)	Maximum number of adaptors: 7	
	Management points	Maximum number of management points: 650 (Number of D connection management points: 512)	
	Areas	Maximum number of areas: 650 Maximum area hierarchies: 10	
	Supported languages	English, French, German, Italian, Spanish, Portuguese, Dutch, Chinese, and Japanese	
	Monitoring screens	Icon view	Icons show the operation status of equipment.
		List view	Detailed information of each management point is displayed.
		Layout view	Up to 60 screens can be created. (Engineering option)
History	Up to 500,000 events are recorded in history including malfunctions, operations, automatic control, and system information. Operation origin is also recorded.		
Automatic control	Schedule	Number of programmes: 100 Up to 20 actions/day can be set.	
		Weekly schedule	7 days of the week + 5 special days can be set.
		Yearly calendar	Special days can be specified by date or month/week/day of the week. Special day settings can be reused every year.
		Seasonal schedule	Programmes for respective seasons can be switched by date.
	Interlock	Number of programmes: 500 Interlock is possible for on/off, malfunction, analogue value, and operation mode switching.	
	Emergency stop	Number of programmes: 31	
	Automatic changeover	Number of changeover groups: 512	
	Temperature limit	Number of temperature limit groups: 8 Upper limit range: 32-50°C Lower limit range: 2-16°C	
	Sliding temperature	Number of sliding temperature groups: 8 Outdoor temperature range: 18-34°C Setpoint range: 16-32°C	
	Heating Mode Optimisation (HMO)	Unneeded heating is prevented.	
	Timer extension	Operation stop is selectable from 30, 60, 90, 120, 150, and 180 minutes.	
Setback	Setback setpoint can be set for 2 patterns. Temperature range: 1-7°C, -1--7°C (setpoint shift amount)		
Data control	Power Proportional Distribution	Hourly Power Proportional Distribution results up to 13 months are recorded. The system supports data output in CSV format.	
	Energy Navigator	Actual results of daily/monthly energy consumption are shown in graphs. Comparisons can be made with predetermined values/actual results of the previous year. Inefficient operation of VRV indoor units is automatically identified, and energy waste is calculated.	
Remote access	Web access	Web browsers can display the same type of screen as the <i>intelligent Touch Manager</i> . Up to 4 administrators and 60 general users can be registered. Screens and operation accessible to general users can be restricted.	
	E-mail alerts	Up to 10 e-mail addresses can be set. Addresses for sending malfunction alerts can be set by range of management points. The SMTP server authentication method is selectable from no authentication, POP before SMTP, and SMTP-AUTH.	
System	Automatic registration	Indoor units connected to DIII-NET are automatically detected, and icons for respective models are automatically registered.	
	Security	Screen lock functions are available. Access restrictions can be set for each general user.	
	Screen savers	Screen savers are selectable from 3 patterns.	
	Setting of contact information	Contact information for servicing can be registered.	
Air Conditioning Network Service	Air Conditioning Network Service System	A service agreement needs to be concluded.	
	Energy Saving Air Conditioning Network Service System	A service agreement needs to be concluded.	

# System structure

## intelligent Touch Manager System Overview

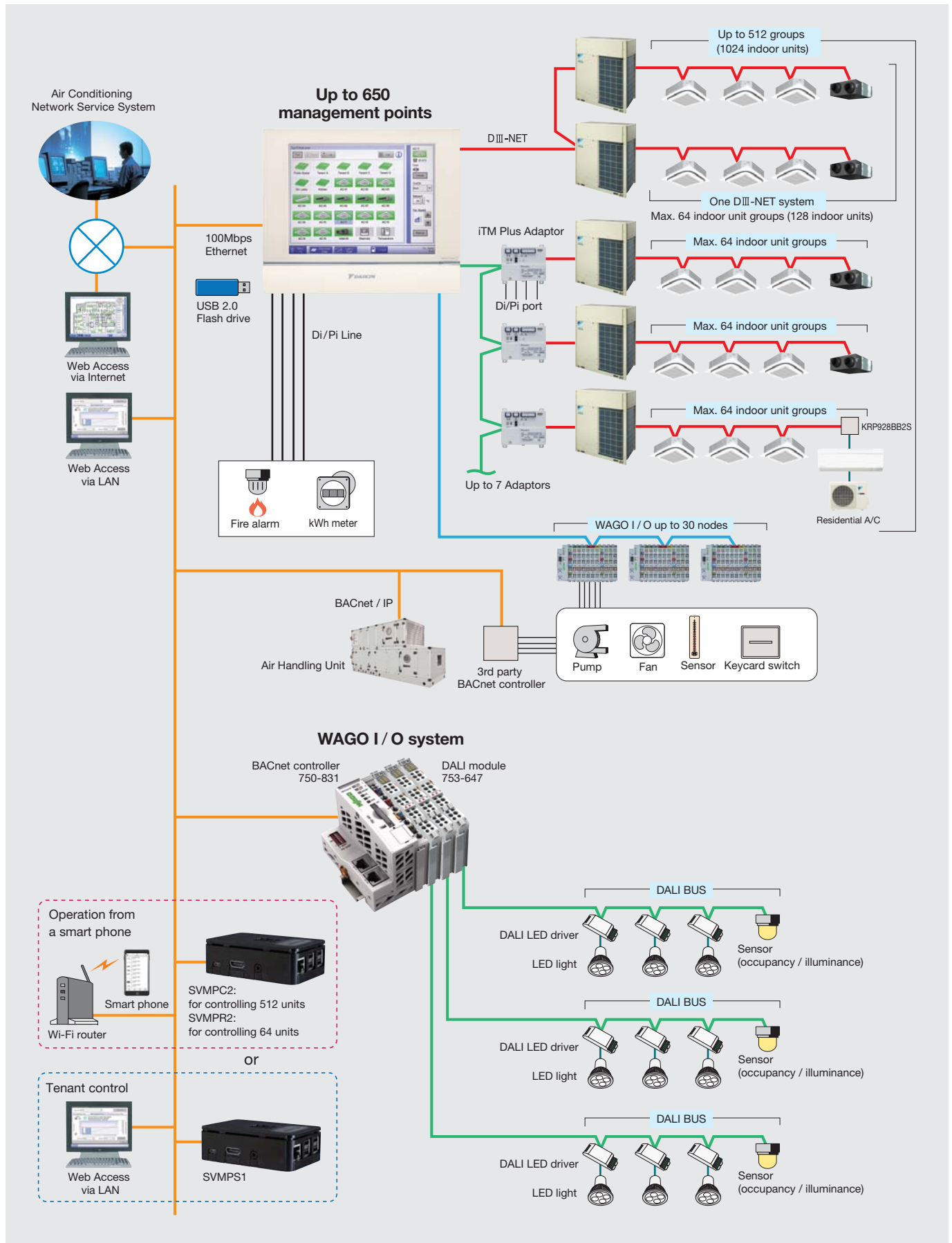

# Specifications

## Types of management points and target equipment / interface

Management point	Supported equipment	Number of management points
Indoor	DIII-compatible indoor units	Maximum: 512 *1
	AHU kit (EKEQFCB,EKEQDCB,EKEQMGB)	
	Interface adaptor for SkyAir (DTA102A52 , DTA112BA51)	
	Interface adaptor for residential indoor unit (KRP928BB2S)	
	Central control adaptor kit for package A/C (DTA107A55)	
Outdoor	VRV outdoor units	Maximum: 80
Ventilator	Heat Reclaim Ventilator	Maximum: 512 *1
D3 Chiller	DIII-compatible air-cooled chillers (UWA/Y) / water-cooled chillers (ZUW)	Maximum: 320 *2
Di	Di port of <i>intelligent Touch Manager</i>	Maximum: 32 *3
	Di port of <i>iTM plus adaptor</i>	
D3 Di	DIIIDi Unit (DEC101A51)	Maximum: 512 *1
External Di	WAGO Di	Maximum: 512 *4
D3 Dio	DIIIDio Unit (DEC102A51)	Maximum: 512 *1
	General-purpose adaptor (DTA103A51)	
External Dio	WAGO Di, Do	Maximum: 512 *4
Pi	Pi port of <i>intelligent Touch Manager</i>	Maximum: 32 *3
	Pi port of <i>iTM plus adaptor</i>	
Internal Pi	Energy consumption of VRV outdoor units	Maximum: 80
External Pi	WAGO Pi (Not available for PPD function)	Maximum: 512 *4
External Ao	WAGO Ao	
External Ai	WAGO Ai	
Internal Ai	Outdoor temp of Outdoor unit Room temperature, setpoint of indoor units D3 Chiller outleta/inlet water temperatures	Maximum: 512 *4
BACnet Di	BACnet object BI/BO/BV can be linked	Maximum: 512 *5
BACnet Dio	BACnet object BI/BO/BV can be linked	
BACnet Ai	BACnet object AI/AO/AV can be linked	
BACnet Ao	BACnet object AO/AV can be linked	
AHU *6	BACnet connectable AHU using MicroTech III	Maximum: 20

\*1: Total of DIII connection equipment (Indoor, Ventilator, D3 Chiller, D3 Di, D3 Dio) \*2: Maximum number of management points for D3 Chiller only

\*3: Total of Di/Pi management points \*4: Total of External Di, External Dio, External Ai, External Ao, External Pi and Internal Ai \*5: Total of BACnet points (include AHU\*6) \*6: AHU count as 20 BACnet points

## DAIKIN supplied equipment & Software option

Model	Item	
DCM601A51	<i>intelligent Touch Manager</i>	
DCM601A52	<i>iTM plus adaptor</i> (Option)	
DCM002A51	iTM power proportional distribution software (Option)	
DCM007A51	HTTP interface software (Option)	
DCM008A51	iTM energy navigator software (Option)	
DCM009A51	BACnet client software (Option)	
WAGO I/O system	Di module (DC24V/4.5mA) : 750-400,750-432	Thermistor module (Pt 1000/RTD) : 750-461/000-003,750-460/000-003
	Di module (DC24V/2.8mA) : 750-430	Thermistor module (Ni 100/RTD) : 750-461/000-004
	Do module (AC230V/DC30V 2A) : 750-513/000-001	Thermistor module (Ni 1000 TK6180/RTD) : 750-461/000-005,750-460/000-005
	Do module (DC24V 0.5A) : 750-504	Pi module : 750-638
	Ai module (4~20mA 12bit) : 750-454,750-455	DC24V Power supply unit : 787-712
	Ai module (-10~10V 13bit) : 750-479	Modbus Communication unit : 750-315/000-002/K190-6442 (DAIKIN custom)
	Ai module (0~10V 12bit) : 750-459	Terminator module : 750-600
	Ao module (4~20mA 12bit) : 750-554,750-555	Power module : 750-613
	Ao module (0~10V 10bit) : 750-560	Connector : 750-960
	Ao module (0~10V 12bit) : 750-559	BACnet DALI module
	Thermistor module (NTC20K) : 750-461/020-000	WAGO BACnet controller module : 750-831
	Thermistor module (Pt 100/RTD) : 750-461/750-460	WAGO DALI master module : 753-647
		WAGO DALI DC power supply module : 753-620

## Locally supplied equipment

Item	Specification
USB memory	USB 2.0 Up to 32GB memory can use
PC for Web access	Web browser : Internet Explorer 11 Firefox 26.0
	Chrome 32.0
	Flash Player Ver11.9.900.170

## SVM Series Model

Model	Comment
SVMR2	VRV Smart Phone Control System for residence
SVMPC2	VRV Smart Phone Remote Controller for building
SVMPS1	Tenant Billing System with PPD

# Main specifications

## intelligent Touch Manager

Port	Number	Use
DIII	1ch	DIII-NET (Up to 64 groups)
LAN	1ch	Web Access (100BASE-TX)
RS485	1ch	External I/O module (Di,Dio,Ai,Ao,Pi)
Di(Pi)	4ch	Emergency stop input (Di1) Pulse input,contact signal input
plus ADP IF	1ch	<i>iTM plus adaptor</i> (Up to 7 adaptors)
internal modem (option)	1ch	Air Conditioning Network Service System

POWER SUPPLY : DCM601A51 AC100-240V(±10%)(50/60Hz)  
 INPUT : 23W  
 MASS : 2.4kg  
 FUSE AMP : 3.15A  
 Operating temperature limit : -0°C - +40°C  
 Operating humidity limit : MAX.15 - 85%  
 Storage temperature range : -15°C - +60°C  
 Installation direction : Vertical direction only

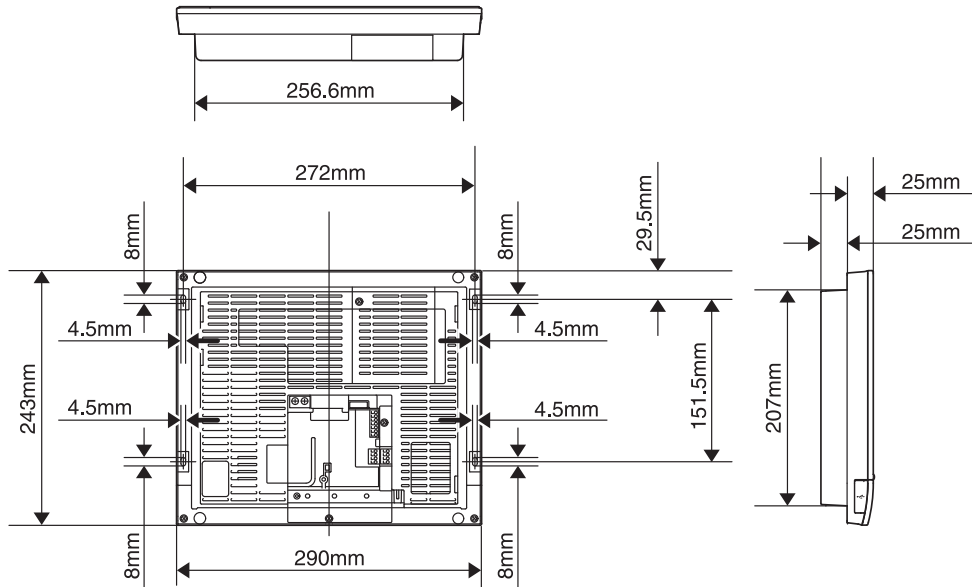

## *iTM plus adaptor* (DCM601A52) Input / Output port

Port	Number	Use
plus ADP IF	1ch	<i>iTM plus adaptor</i> (Up to 7 adaptors)
DIII	1ch	DIII-NET (Up to 64 groups)
Di(Pi)	4ch	Pulse input,contact signal input

POWER SUPPLY : DCM601A52 AC100V-240V(±10%)(50/60Hz)  
 INPUT : 6W  
 MASS : 0.5kg  
 FUSE AMP : 3.15A  
 Operating temperature limit : -10°C - +50°C  
 Operating humidity limit : MAX.15 - 85%  
 Storage temperature range : -15°C - +60°C  
 Installation direction : Vertical direction only

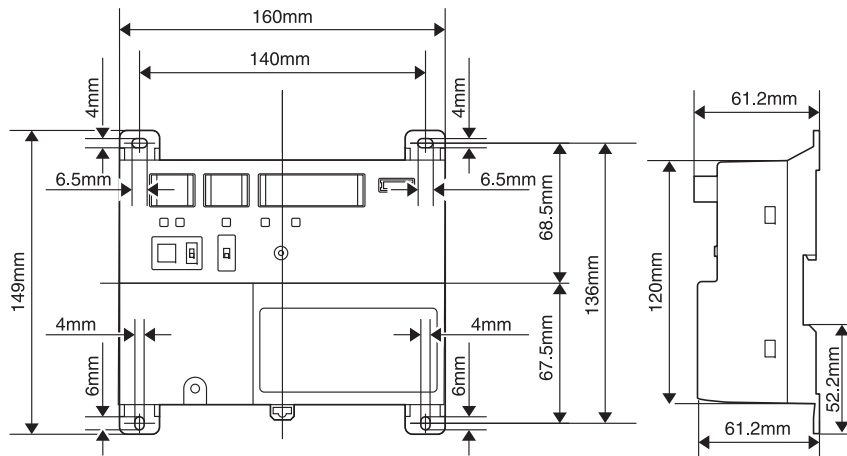

## Air Conditioning Network Service System

### Preventive Maintenance

The *intelligent Touch Manager* can be connected to Daikin's own Air Conditioning Network Service System for remote monitoring and verification of operation status for VRV system. By its ability to predict malfunctions, this service provides customers with additional peace of mind.

### Enhanced convenience with link to the Air Conditioning Network Service System

The *intelligent Touch Manager* connects seamlessly to Daikin's 24-hour Air Conditioning Network Service System.

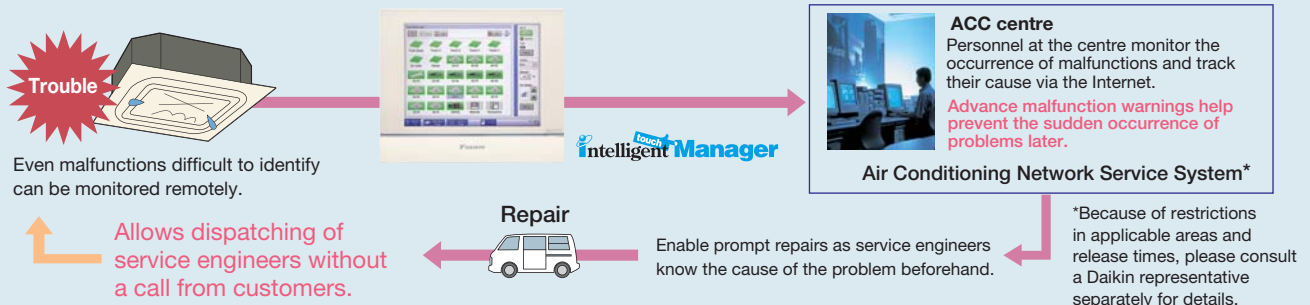

## Daikin Offers a Variety of Control Systems

### Convenient controllers that offer more freedom to administrators



### intelligent Touch Controller

#### Ease of use and expanded control functions

The user-friendly controller features colours, multilingual function, and icons in the display for ease of understanding. A wide variety of control methods can be accommodated, permitting administrators to monitor and operate the system even when they are away from the controller.

DCS601C51

### Connect VRV system to your BMS via BACnet® or LONWORKS®

Compatible with BACnet® and LONWORKS®, the two leading open network communication protocols, Daikin offers interfaces that provide a seamless connection between VRV system and your BMS.

Dedicated interfaces make Daikin air conditioners freely compatible with open networks



DMS502B51  
(Interface for use in BACnet®)

#### BACnet®

Seamless connection between VRV system and BACnet® open network protocol.



DMS504B51  
(Interface for use in LONWORKS®)

#### LonWORKS®

Facilitating the network integration of VRV system and LONWORKS®

Notes: 1. BACnet® is a registered trademark of American Society of Heating, Refrigerating and Air-Conditioning Engineers (ASHRAE).

2. LONWORKS® is a trademark of Echelon Corporation registered in the United States and other countries.

### Using intelligent Touch Manager

1. A Daikin-trained engineer must perform installation of the *intelligent Touch Manager*.
2. The clock of the *intelligent Touch Manager* should be adjusted once a month.
3. Daikin's unique PPD system calculates the energy consumption of each indoor unit based on its operation data output. Note that PPD is not a "meter" adapted to the methods of measuring electrical power consumption in each country. Tenant billing systems differ by country according to each country's respective legal system. Data obtained by PPD is for reference use only and should not be used for official financial transactions.

#### Dealer

#### DAIKIN INDUSTRIES, LTD.

Head Office:  
Umeda Center Bldg., 2-4-12, Nakazaki-Nishi,  
Kita-ku, Osaka, 530-8323 Japan

Tokyo Office:  
JR Shinagawa East Bldg., 2-18-1, Konan,  
Minato-ku, Tokyo, 108-0075 Japan

<http://www.daikin.com>

© All rights reserved  
06/16 AD